

- Manufacturing from 12L14 Material
- Surface treated for corrosion resistance

Hot Runner Locating Rings

- Locating Rings for your Hot Runner Tools that use 1/4" or 1/2" insulating sheets (not included)

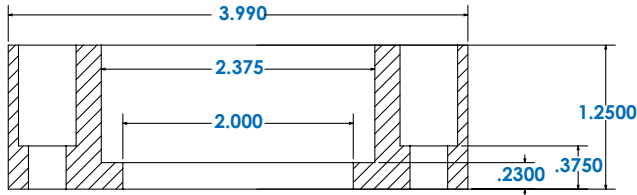

CLR521HR
Price \$39.50

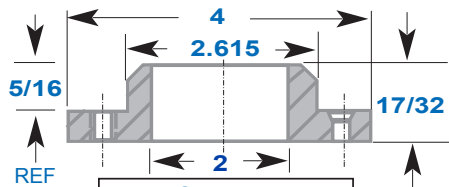
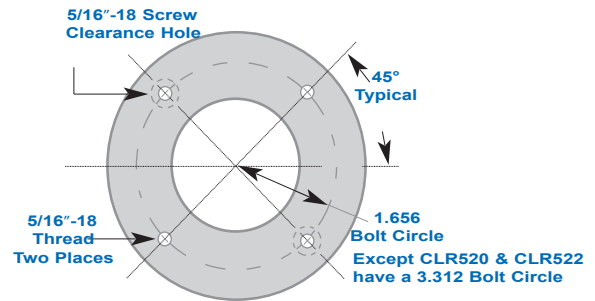

CLR500
Price \$22.00

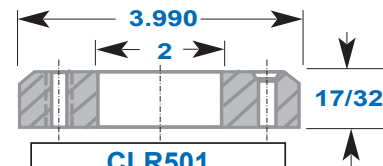

CLR501
Price \$19.00

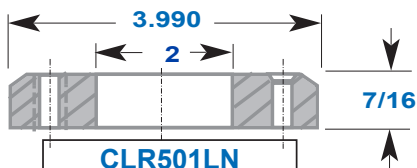

CLR501LN
Price \$17.00

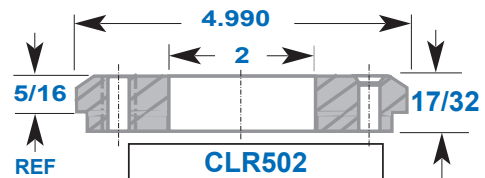

CLR502
Price \$29.00

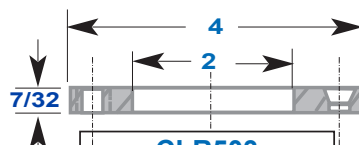

CLR503
Price \$17.00

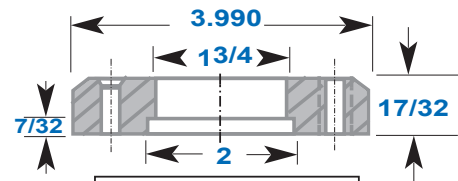

CLR504
Price \$23.00

Prices subject to change without notice

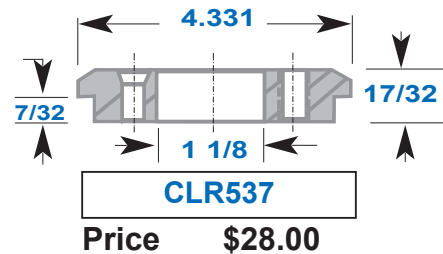
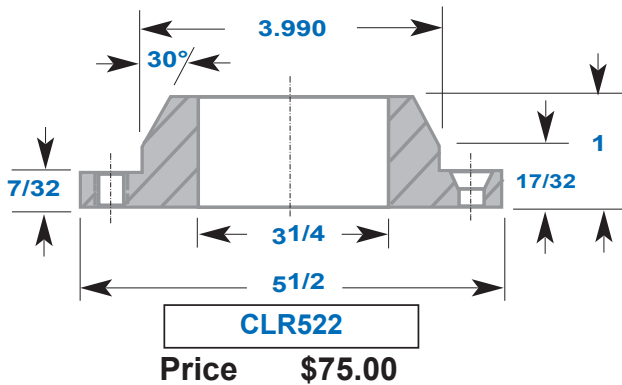
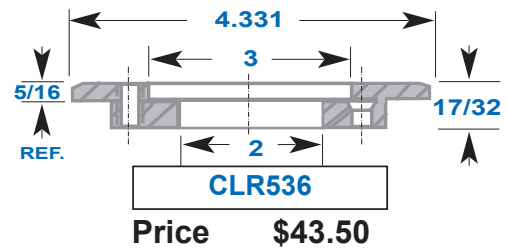
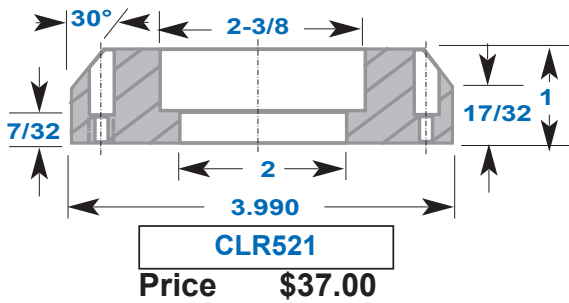
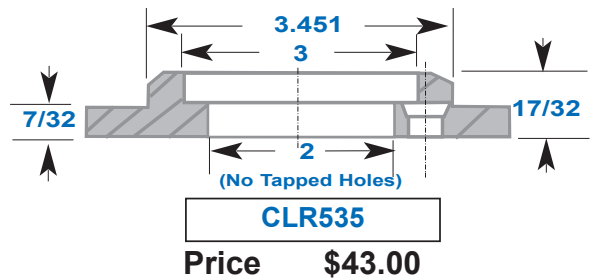
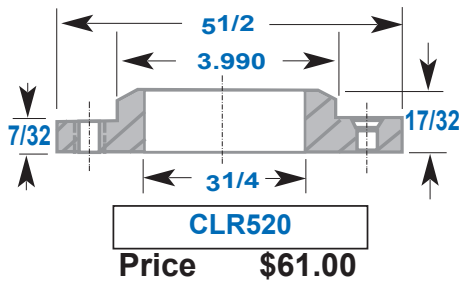
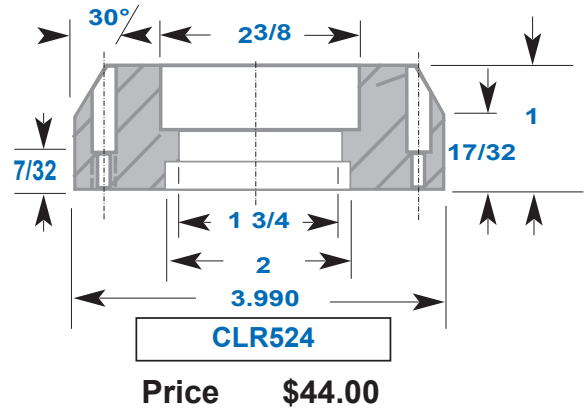
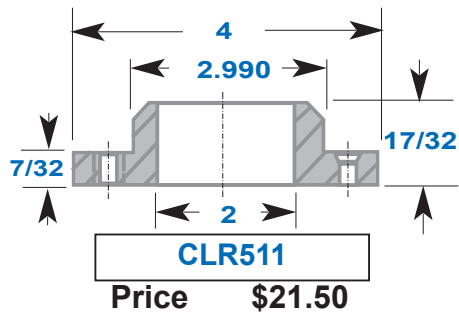

Prices subject to change without notice